

Star Beam (SB)

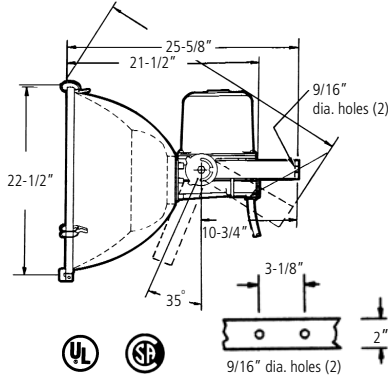

Suitable for wet locations
Lamp not included



Solid Line - NEMA Heavy Duty
Dotted Line - NEMA General Purpose

Star Beam Specification

Star Beam sports lighting floodlight (specify) general purpose; heavy duty or extra heavy duty cast aluminum outer housing. Totally weatherproof construction, shall accommodate a 250, 400 or 1,000 watt mogul base high pressure sodium lamp or a 250, 400, 1,000 or 1,500 watt mogul base metal halide lamp. Available with (specify) 120, 208, 240, 277, 347, 480 volt or 4MT (120,208,240,277V), 60Hz ballast. The floodlight shall be completely pre-wired and factory assembled. Floodlight shall be NEMA type 2, 3, 4, 5 or 6 beam spread.

Basic Product Description

Shipped as a complete unit in one carton for ease of installation and servicing. Die cast ballast housing, socket housing and wiring compartment is finned for cooler ballast operation and longer ballast life. Floodlight is finished in all weather bronze polyester powder coating (optional colors are available). Floodlight shall include a weatherproof strain relief bushing, sturdy two hole mounting yoke formed of high strength non-corrosive copper free aluminum, degree quadrant with positive repositioning stop. There shall be a removable beam sight.

Ballast Characteristics

The floodlight shall contain a U.L. recognized High Power Factor, constant wattage auto-transformer type ballast and start and operate the lamp down to -20°F (-30°C) for metal halide and -40°F (-40°C) for high pressure sodium. Mercury vapor lamps may be used in 250, 400, or 1000 watt metal halide fixtures. For availability of 220/240V 50Hz ballasts - consult factory.

Reflector Assembly

The sealed reflector assembly shall include a 21" diameter one-piece spun aluminum electro brite reflector, three quick-release stainless steel latches secure the lens frame to the reflector. The stainless steel lens frame is hinged at the bottom and swings clear for ease of servicing. A one piece high temperature silicone gasket seals the thermal shock, heat resistant, tempered clear glass lens.

Heavy Duty Outer Housing Options

Shall include a heavy-gauge spun aluminum bronze outer housing (standard).

OR

Shall include a finned cast aluminum bronze outer housing for extra protection "-HD".

Ordering Example

Unit	Wattage	NEMA Beam Type	Mounting	Lamp Type	Voltage	Ballast Sstyle	Options		
Star Beam	4 - 250	2 - 2 x 2	1-Yoke Mount	H - Metal Halide	120	H - High Power Factor	LH - General Purpose		
	6 - 400	3 - 3 x 3		LS - High Pressure Sodium	208				
	8 - 1000	4 - 4 x 4			240				
	9 - 1500	5 - 5 x 5			277			No Suffix - Heavy Duty Spun Housing	
		6 - 6 x 6			480				
					4MT- (120, 208, 240, 277V)				
					347				
					RBH - Remote Ballast				HD - Heavy Duty Cast Aluminum Housing
			Accessories						
			V* -	Visor					
			LS -	Lamp Support					
			F -	Single Fuse (120,277v)					
			DF -	Double Fuse (208, 240, 480v)					
			FB -	Filter Breather					
			SC -	Stainless Steel Safety Cable					
			RPC -	Factory Wired Twist lock photocell receptacle ONLY					
			PE -	Twist Lock Photocell					
			SSG* -	Stainless Steel Wire Guard					
			CLR* -	Concentric Ring Louvre					
			3/14/350 -	3 ft. cord. for other length change 3' to length desired					
			UP* -	for aiming above horizontal					
			PL* -	Polycarbonate Shield					
			POS -	Position-Oriented Socket					

*Must be factory installed

Star Beam (SB)

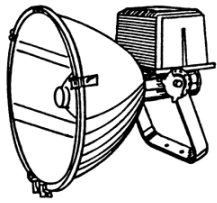

Heavy duty with spun aluminum outer housing (standard no suffix)

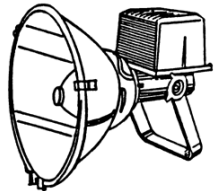

General Purpose ("LH") Less Outer Housing

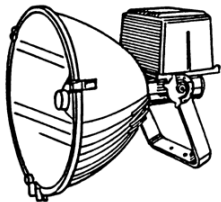

Heavy duty with cast aluminum outer housing ("HD")

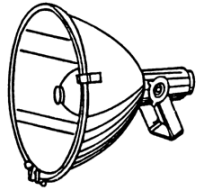

Remote Ballast ("RBH")

Sports Lighting Applications

Baseball, football, softball and soccer field, tennis courts, driving ranges and other athletic fields and stadiums.

Specification Features

- Stainless steel hardware and lens ring.
- Thermal shock and impact resistant tempered glass lens.
- Copper-free aluminum yoke.
- Completely factory assembled. No field assembly required.
- Die cast ballast & socket housing.
- Positive repositioning stop.
- Porcelain mogul base socket.

Effective Projected Area

EPA = 2.35 SQ. FT.
Weight = 50-67 lbs

Cord Grip for #12, #14, or #16 cable.

3' #14/3 SO Cord is available, ordering suffix 3/14/3SO.
For other cord lengths replace 3 with length required. Factory installed.

Accessories (Must be ordered with fixture)



Polycarbonate Shield "PL"



Concentric Ring Louvre "CRL"

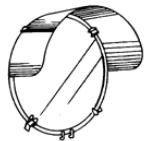

Visor "V"



Stainless Steel Wire Guard "SSG"



Single Fuse "F"
Double Fuse "DF"



Lamp Support "LS"

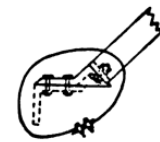

1/8" Stainless Steel Cable "SC"

Mounting Brackets

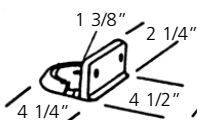

SB-2*

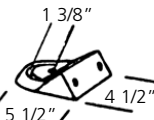

SB-245*

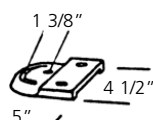

SB-290*

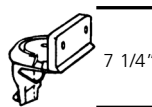

SB-3



SB-5

*For Horizontal Yoke Mounting, 180° Adjustment - Includes (2) 1/2" Bolts

Wall or 2" Pipe Clamp Mount. Supplied with 2 "U" Bolts

Fits 2" to 2 1/2" pipe (2 3/8" to 2 7/8" OD)



Star Beam (SB)

Photometrics

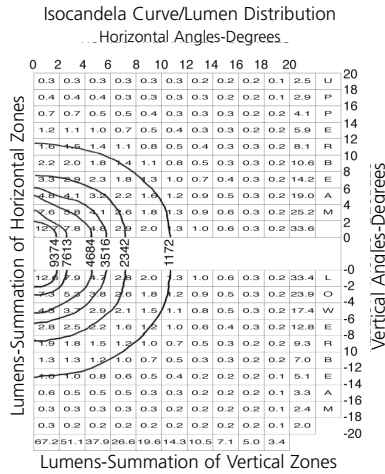
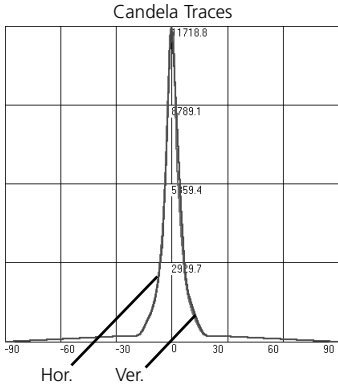

Fixture: SB-821H
 Lamp: 1000 or 1500 Watt Metal Halide

IES Type 2H X 2V
 Max Candela 11718
 Hor Beam Angle (50%) 7.2 deg
 Ver Beam Angle (50%) 7.7 deg
 HOR Field Angle (10%) 21.6 deg
 VER Field Angle (10%) 22.5 deg
 Field Lumens 336
 Field Efficiency 33.6%

Candela & Lumen values are based on 1,000 lamp lumens. For other lamp lumen ratings, multiply candela and lumen values by the number: Lumens divided by 1,000.

Per 1,000 Lamp Lumens

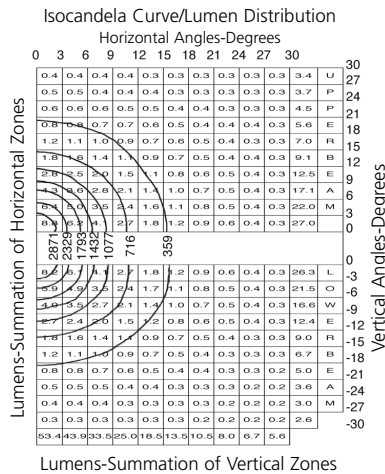
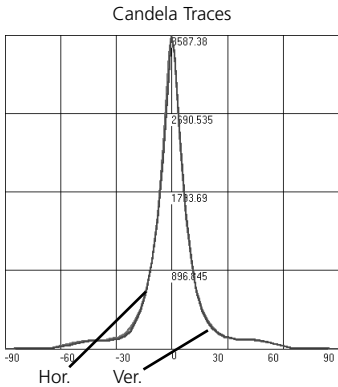

Fixture: SB-831H
 Lamp: 1000 or 1500 Watt Metal Halide

IES Type 3H X 3V
 Max Candela 3587
 Hor Beam Angle (50%) 13.0 deg
 Ver Beam Angle (50%) 12.9 deg
 HOR Field Angle (10%) 37.4 deg
 VER Field Angle (10%) 36.6 deg
 Field Lumens 311
 Field Efficiency 31.1%
 Total Lumens 618
 Total Efficiency 61.8%

Candela & Lumen values are based on 1,000 lamp lumens. For other lamp lumen ratings, multiply candela and lumen values by the number: Lumens divided by 1,000.

Per 1,000 Lamp Lumens

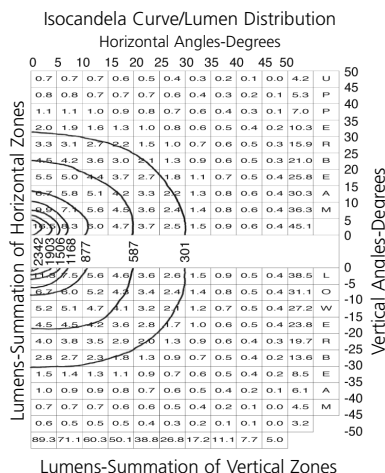
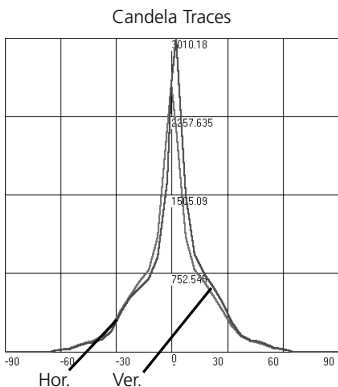

Fixture: SB-841H
 Lamp: 1000 or 1500 Watt Metal Halide

IES Type 4H X 4V
 Max Candela 3010
 Hor Beam Angle (50%) 11.2 deg
 Ver Beam Angle (50%) 10.5 deg
 HOR Field Angle (10%) 60.7 deg
 VER Field Angle (10%) 61.3 deg
 Field Lumens 558
 Field Efficiency 55.8%
 Total Lumens 774
 Total Efficiency 77.4%

Candela & Lumen values are based on 1,000 lamp lumens. For other lamp lumen ratings, multiply candela and lumen values by the number: Lumens divided by 1,000.

Per 1,000 Lamp Lumens

Star Beam (SB)

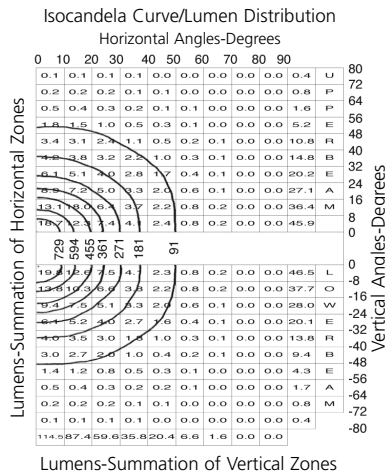
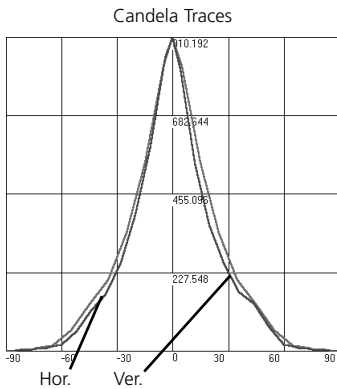

Fixture: SB-851H
Lamp: 1000 or 1500 Watt Metal Halide

IES Type 6H X 5V
Max Candela 910
Hor Beam Angle (50%) 38.9 deg
Ver Beam Angle (50%) 33.7 deg
HOR Field Angle (10%) 101.9 deg
VER Field Angle (10%) 97.2 deg
Field Lumens 591
Field Efficiency 59.1%
Total Lumens 650
Total Efficiency 65.0%

Candela & Lumen values are based on 1,000 lamp lumens. For other lamp lumen ratings, multiply candela and lumen values by the number: Lumens divided by 1,000.

Per 1,000 Lamp Lumens

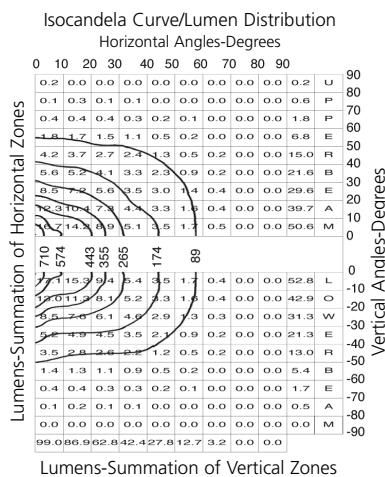
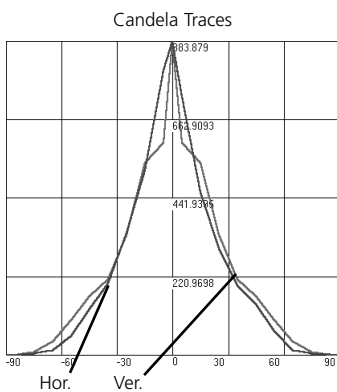

Fixture: SB-861H
Lamp: 1000 or 1500 Watt Metal Halide

IES Type 6H X 6V
Max Candela 883
Hor Beam Angle (50%) 39.9 deg
Ver Beam Angle (50%) 35.6 deg
HOR Field Angle (10%) 113.3 deg
VER Field Angle (10%) 102.7 deg
Field Lumens 609
Field Efficiency 60.9%
Total Lumens 670
Total Efficiency 67.0%

Candela & Lumen values are based on 1,000 lamp lumens. For other lamp lumen ratings, multiply candela and lumen values by the number: Lumens divided by 1,000.

Per 1,000 Lamp Lumens

For further information consult factory

