

Canopy (TCM)

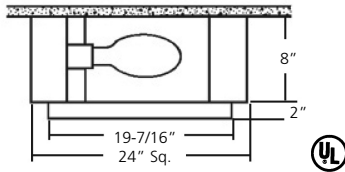

Lamp included
Suitable for damp locations

WEIGHT = 34-43 lbs



TCM Series Specification

TCM Series is a surface mounted wide beam luminaire. Available in 250 to 400 watt mogul base high pressure sodium lamp and 250 to 400 watt mogul base metal halide lamp. Available with (specify) 120, 208, 240, 277, 480 volt, or 4MT (120,208,240,277V) 60Hz ballast. Luminaire shall be completely pre-wired for ease of installation.

Basic Product Description

One-piece steel housing with weather tight welded and finished corners, sealing out moisture and dust. High quality baked white polyester powder coating will withstand extreme temperature change without cracking, peeling or fading. Hinged aluminum lens frame fully opens for easy lamp access. A single capture screw secures the lens frame to the housing. A one-piece E.P.D.M. gasket provides maximum sealing between the housing and lens frame. Three types of lenses and diffusers are available, Corning #73 (CO), drop prismatic acrylic (LXA), and drop prismatic polycarbonate (LXP). Porcelain lamp socket with spring loaded center contact eliminates lamp loosening.

Ballast Characteristics

TCM Series shall contain a long lasting, U.L. recognized High Power Factor (HPF) constant wattage auto-transformer (CWA) type ballast. Will start lamps at -20°F (-30°C) for metal halide and -40°F (-40°C) for high pressure sodium. Mercury vapor lamps may be used in 250-400 watt metal halide fixtures. For availability of 220/240V, 50Hz ballast - consult factory.

Reflector Assembly

One-piece precision formed alzak finished reflector provides a uniform symmetrical distribution.

Suggested Applications

Under canopy lighting for gas stations, convenience stores and hotels.

Note:

TCM 400 Series should be mounted to concrete or metal ceilings only.

Ordering Example

Unit	Wattage	Photometrics	Mounting	Lamp Style	Voltage	Ballast Style	Options
TCM	4	5	8	H	120	H	LXA
TCM	4 - 250 6 - 400 200 - 200PS 320 - 320PS 350 - 350PS 400 - 400PS	5 - Wide Beam	8- Surface Mount	H - Metal Halide LS - High Pressure Sodium	120 208 240 277 480 4MT- (120, 208, 240, 277V)	H - High Power Factor	CO - Corning #73 LXA - Drop Prismatic Acrylic LXA - Drop Prismatic Polycarbonate (consult factory)
Accessories							
SIF							
SIF - Single Inline Fuse							
DIF - Double Inline Fuse							
EM - Emergency Quartz Relay and Socket (consult factory)							
EM60 - Emergency Quartz Delay Relay and Socket (consult factory)							
QS - Quartz Socket Only (aux. power required, consult factory)							
DP - Damp Location							
TP - Tamper Resistant Screws							
POS - Position Oriented Socket							
CSA Certification - consult factory.							

TCM Series (TCM)

Photometrics

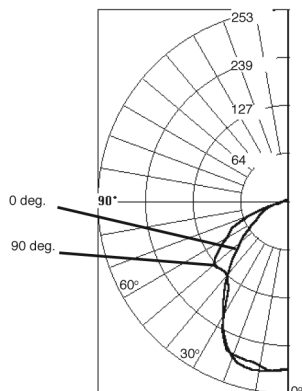

ZONE	LUMENS	%LAMP	%FIXT
0-30	177.0	17.7	29.0
0-40	276.0	27.6	45.2
0-60	475.0	47.5	77.8
0-90	593.0	59.3	97.1
90-180	18.0	1.8	2.9
0-180	611.0	61.1	100.0

COEFFICIENTS OF UTILIZATION - ZONAL CAVITY METHOD

	80				70				50				30				10				0
	70	50	30	10	70	50	30	10	50	30	10	50	30	10	50	30	10	50	30	10	0
0	72	72	72	72	70	70	70	70	67	67	67	64	64	64	61	61	61	59	59	59	59
1	67	64	61	59	65	62	60	58	59	58	56	57	55	54	54	53	52	51	51	51	51
2	61	57	53	50	60	55	52	49	53	50	48	51	48	46	49	47	45	44	44	44	44
3	56	50	46	42	55	49	45	42	47	44	41	45	42	40	44	41	39	38	38	38	38
4	52	45	40	36	50	44	40	36	43	39	35	41	38	35	39	37	34	33	33	33	33
5	48	40	35	32	46	40	35	31	38	34	31	37	33	30	36	32	30	29	29	29	29
6	44	36	31	27	43	36	31	27	34	30	27	33	29	27	32	29	26	25	25	25	25
7	41	33	27	24	39	32	27	24	31	27	23	30	26	23	29	25	23	22	22	22	22
8	38	30	25	21	37	29	24	21	28	24	21	27	23	21	27	23	20	19	19	19	19
9	35	27	22	19	34	27	22	19	26	22	19	25	21	18	24	21	18	17	17	17	17
10	33	25	20	17	32	24	20	17	24	19	17	23	19	16	22	19	16	15	15	15	15

Catalog Number: TCM-658H-LX (A-B)
see below

Lamp: Clear "Super" Metal Halide

Reflector: Curved diffuse aluminum reflector and flat panel on socket end, formed plastic prismatic drop enclosure

Efficiency: 61.1%

CIE Type: Direct

Luminaire Spacing Criteria: 1.2 - 0 Deg.
1.2 - 0 Deg.

Candela & Lumen values are based on 1,000 lamp lumens. For other lamp lumen ratings, multiply candela and lumen values by the number: Lumens divided by 1,000.

Per 1,000 Lamp Lumens

DEG	CANDELA	LUMENS
0	0.0	90.0
0	223.0	223.0
5	225.0	21.0
15	227.0	62.0
25	200.0	94.0
35	149.0	99.0
45	104.0	98.0
55	67.0	101.0
65	42.0	73.0
75	25.0	32.0
85	11.0	13.0
90	7.0	7.0
95	6.0	8.0
105	4.0	5.0
115	3.0	3.0
125	2.0	1.0
135	1.0	0.0
145	0.0	0.0

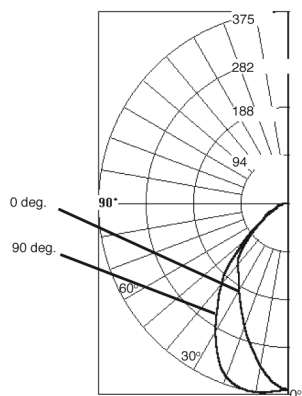

ZONAL LUMEN SUMMARY			
ZONE	LUMENS	%LAMP	%FIXT
0-30	236.0	23.6	40.4
0-40	354.0	35.4	60.6
0-60	520.0	52.0	89.1
0-90	584.0	58.4	100.0
90-180	0.0	0.0	0.0
0-180	584.0	58.4	100.0

COEFFICIENTS OF UTILIZATION - ZONAL CAVITY METHOD

	80				70				50				30				10				0
	70	50	30	10	70	50	30	10	50	30	10	50	30	10	50	30	10	50	30	10	0
0	70	70	70	70	68	68	68	68	65	65	65	62	62	62	60	60	60	58	58	58	58
1	65	63	61	59	64	62	60	58	59	58	56	57	56	55	55	54	53	52	52	52	52
2	61	57	54	52	59	56	53	51	54	52	50	52	50	49	51	49	48	47	47	47	47
3	57	52	48	45	55	51	48	45	49	47	44	48	46	43	47	45	43	42	42	42	42
4	53	48	44	40	52	47	43	40	46	42	40	44	41	39	43	41	39	38	38	38	38
5	50	44	39	36	49	43	39	36	42	38	36	41	38	35	40	37	35	34	34	34	34
6	46	40	36	32	45	39	35	32	38	35	32	38	34	32	37	34	32	31	31	31	31
7	43	36	32	29	42	36	32	29	35	31	29	34	31	29	34	31	28	27	27	27	27
8	40	33	29	26	40	33	29	26	32	29	26	32	28	26	31	28	26	25	25	25	25
9	38	31	27	24	37	30	26	24	30	26	24	29	26	23	29	26	23	22	22	22	22
10	35	28	24	21	35	28	24	21	28	24	21	27	24	21	27	26	23	22	22	22	22

Catalog Number: TCM-658H-CO
Lamp: Clear "Super" Metal Halide

Reflector: Curved diffuse aluminum reflector and flat panel on socket end, flat prismatic glass enclosure

Efficiency: 58.4%

CIE Type: Direct

Luminaire Spacing Criteria: 1.2 - 0 Deg.
0.9 - 0 Deg.

Candela & Lumen values are based on 1,000 lamp lumens. For other lamp lumen ratings, multiply candela and lumen values by the number: Lumens divided by 1,000.

Per 1,000 Lamp Lumens

DEG	CANDELA	LUMENS
0	0.0	90.0
0	365.0	365.0
5	371.0	34.0
15	375.0	88.0
25	332.0	115.0
35	244.0	118.0
45	162.0	103.0
55	73.0	64.0
65	42.0	36.0
75	21.0	21.0
85	8.0	7.0
90	0.0	0.0



TCM Series (TCM)

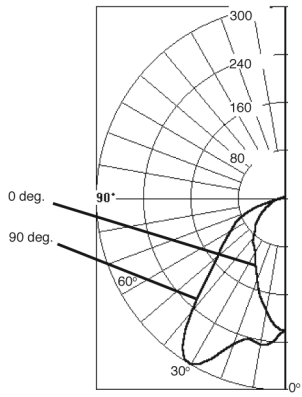

ZONAL LUMEN SUMMARY			
ZONE	LUMENS	%LAMP	%FIXT
0-30	165.0	16.5	26.9
0-40	276.0	27.6	44.9
0-60	474.2	47.4	77.2
0-90	593.0	59.3	96.6
90-180	21.0	2.1	3.4
0-180	61.4	61.4	100.0

COEFFICIENTS OF UTILIZATION - ZONAL CAVITY METHOD																		
	80				70				50				30				10	0
	70	50	30	10	70	50	30	10	50	30	10	50	30	10	50	30	10	0
0	73	73	73	73	71	71	71	71	67	67	67	64	64	64	61	61	61	59
1	67	64	62	59	65	62	60	58	59	58	56	57	55	54	54	53	52	51
2	61	57	53	50	60	55	52	49	53	50	47	51	48	46	49	47	45	43
3	56	50	46	42	55	49	45	41	47	43	40	45	42	40	43	41	39	37
4	52	45	40	36	50	44	39	36	42	38	35	41	37	34	39	36	34	32
5	48	40	35	31	46	39	35	31	38	34	30	37	33	30	35	32	29	28
6	44	36	31	27	43	35	30	27	34	30	26	33	29	26	32	28	26	24
7	40	32	27	23	39	32	27	23	31	26	23	30	26	23	29	25	22	21
8	37	29	24	21	36	29	24	21	28	23	20	27	23	20	26	22	20	19
9	35	27	22	18	34	26	21	18	25	21	18	24	21	18	24	20	18	16
10	32	24	19	16	31	24	19	16	23	19	16	22	18	16	22	18	16	14

Catalog Number: TCM-658H-LX (X-Y)
see below

Lamp: Clear "Super" Metal Halide

Reflector: Curved diffuse aluminum reflector and flat panel on socket end, formed plastic prismatic drop enclosure

Efficiency: 61.4%

CIE Type: Direct

Luminaire Spacing Criteria: 1.7 - 0 Deg.
0.8 - 0 Deg.

Candela & Lumen values are based on 1,000 lamp lumens. For other lamp lumen ratings, multiply candela and lumen values by the number: Lumens divided by 1,000.

Per 1,000 Lamp Lumens

DEG	CANDELA	LUMENS
	0.0	90.0
0	220.0	220.0
5	239.0	212.0
15	243.0	168.0
25	295.0	120.0
35	303.0	94.0
45	187.0	73.0
55	126.0	56.0
65	93.0	36.0
75	43.0	22.0
85	13.0	10.0
90	9.0	8.0
95	8.0	7.0
105	6.0	5.0
115	3.0	4.0
125	2.0	3.0
135	1.0	1.0

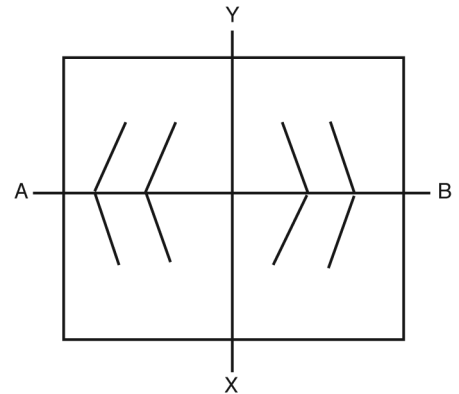

A-B Parallel with lamp axis

X-Y Parallel with lamp axis

